

32" Missile Boat

The OSA class missile boats were one of the most successful classes of naval craft ever designed, with well over 500 built and service in 25 or more navies. They were a further development of the KOMAR class boat (60 tons), which ushered in a new age of naval warfare when two examples of that class sank a destroyer (1700 tons) at a range of 13.6 miles using their missiles. The OSA was a bigger boat, at around 200 tons, with limited blue-water capability, and continued the successful use of anti-ship missiles during Operation Trident/python in the 1971 Indo-Pakistan war, sinking 6 ships and destroying an oil terminal with no losses.

The class has been widely exported to Warsaw Pact and other third-world nations usually with limited defensive capabilities which lays them open to attack with sophisticated modern missiles. But during the 1960s and 1970s these boats posed a huge threat to Western navy forces, with their ability to engage at great distances, far beyond the reach of conventional weaponry.

This model is one of a range of simple 'starter' kits, continuing the tradition of the Keil Kraft 'EeZeBilt' range, which were pocket-money kits intended to introduce youngsters to the hobby of model boat building. They are of simple construction, made of balsa, an easy and forgiving material to work in, and can be made with few tools in a small space such as a bedroom. The interlocking construction used enables youngsters to build things themselves and not to need the services of an adult – this builds confidence and gives pride in the finished item. This will be a realistic boat which will look as good displayed on a shelf as in the water.

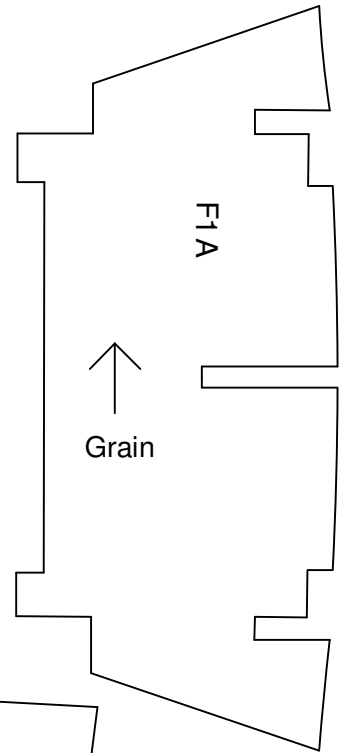
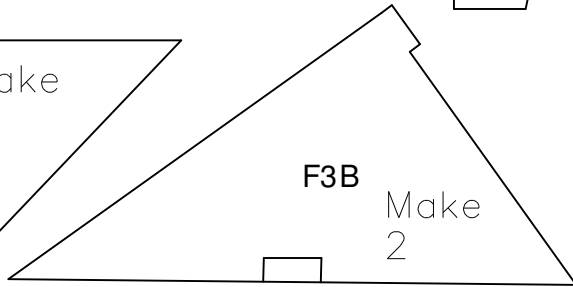
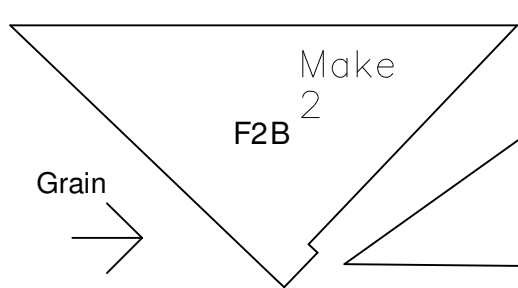
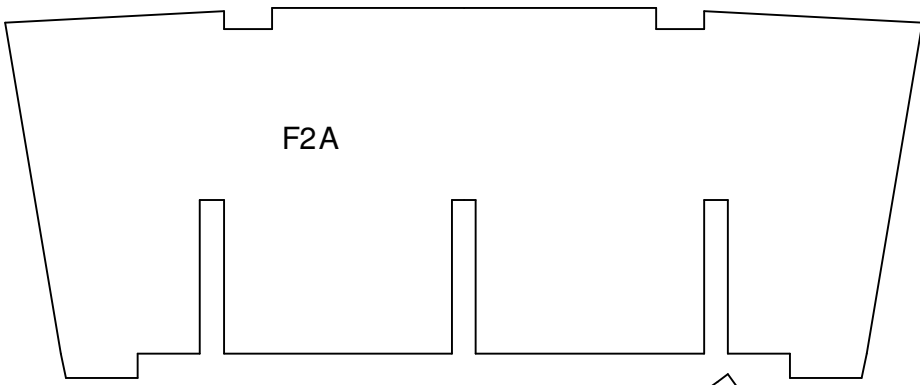

↑
Grain

Grain
→

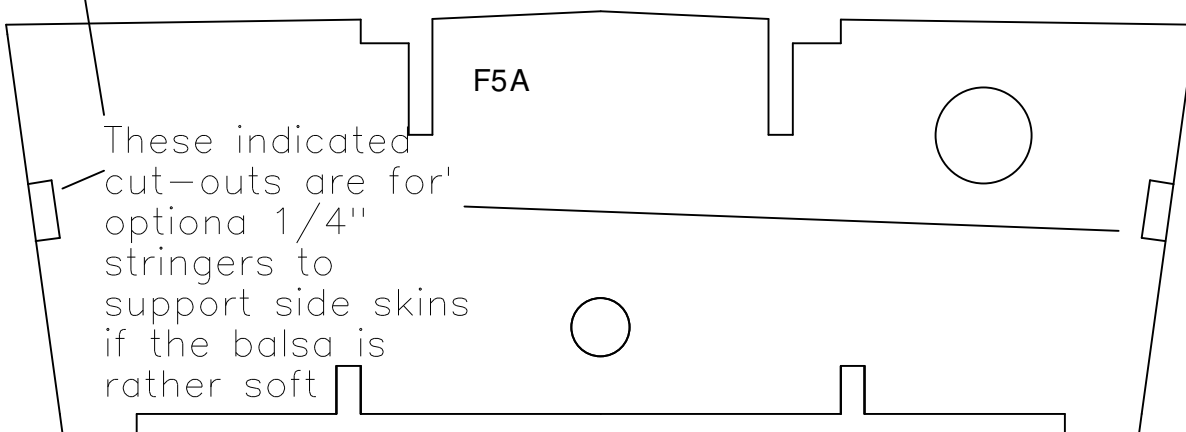
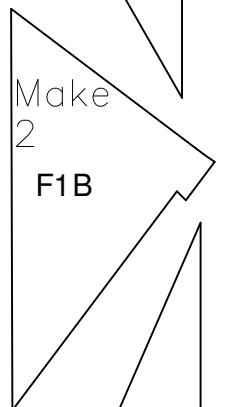
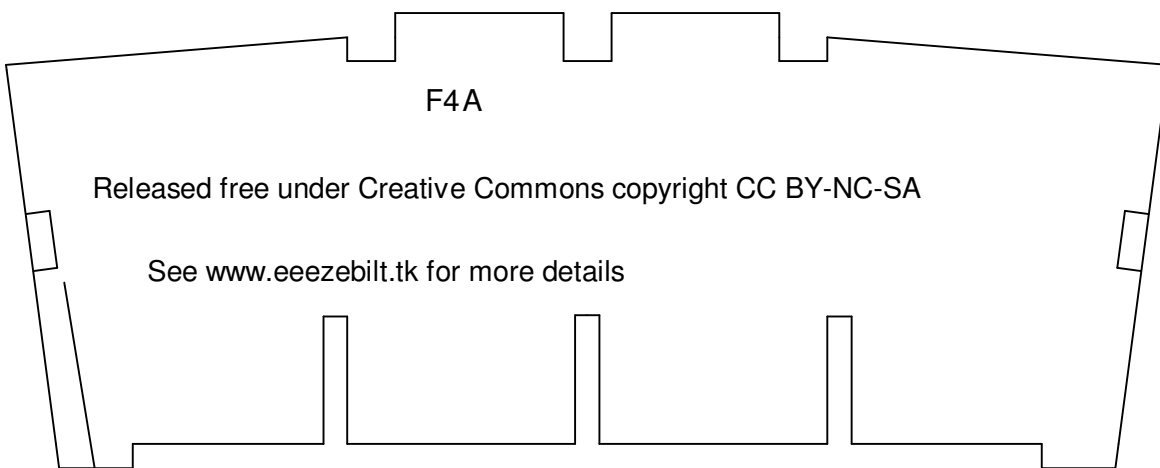
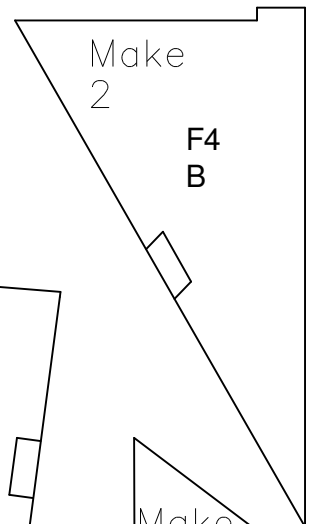
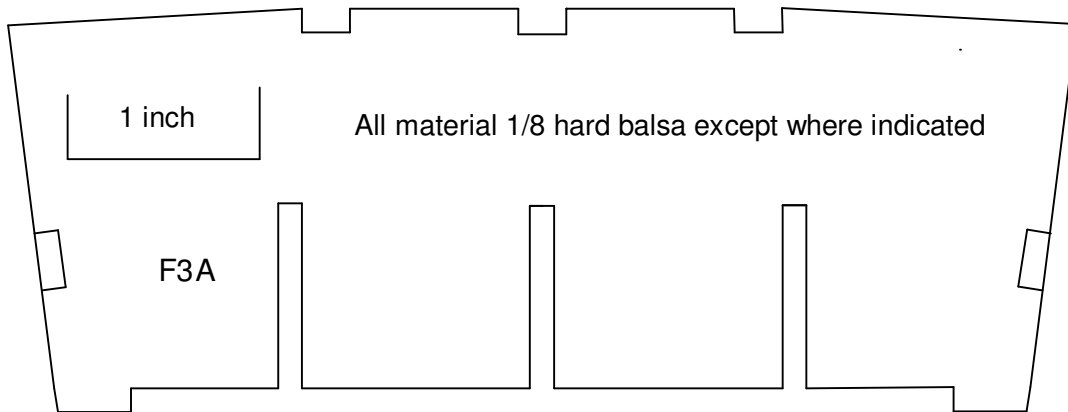

These indicated cut-outs are for optional 1/4" stringers to support side skins if the balsa is rather soft

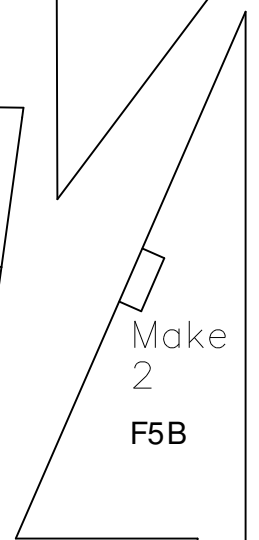

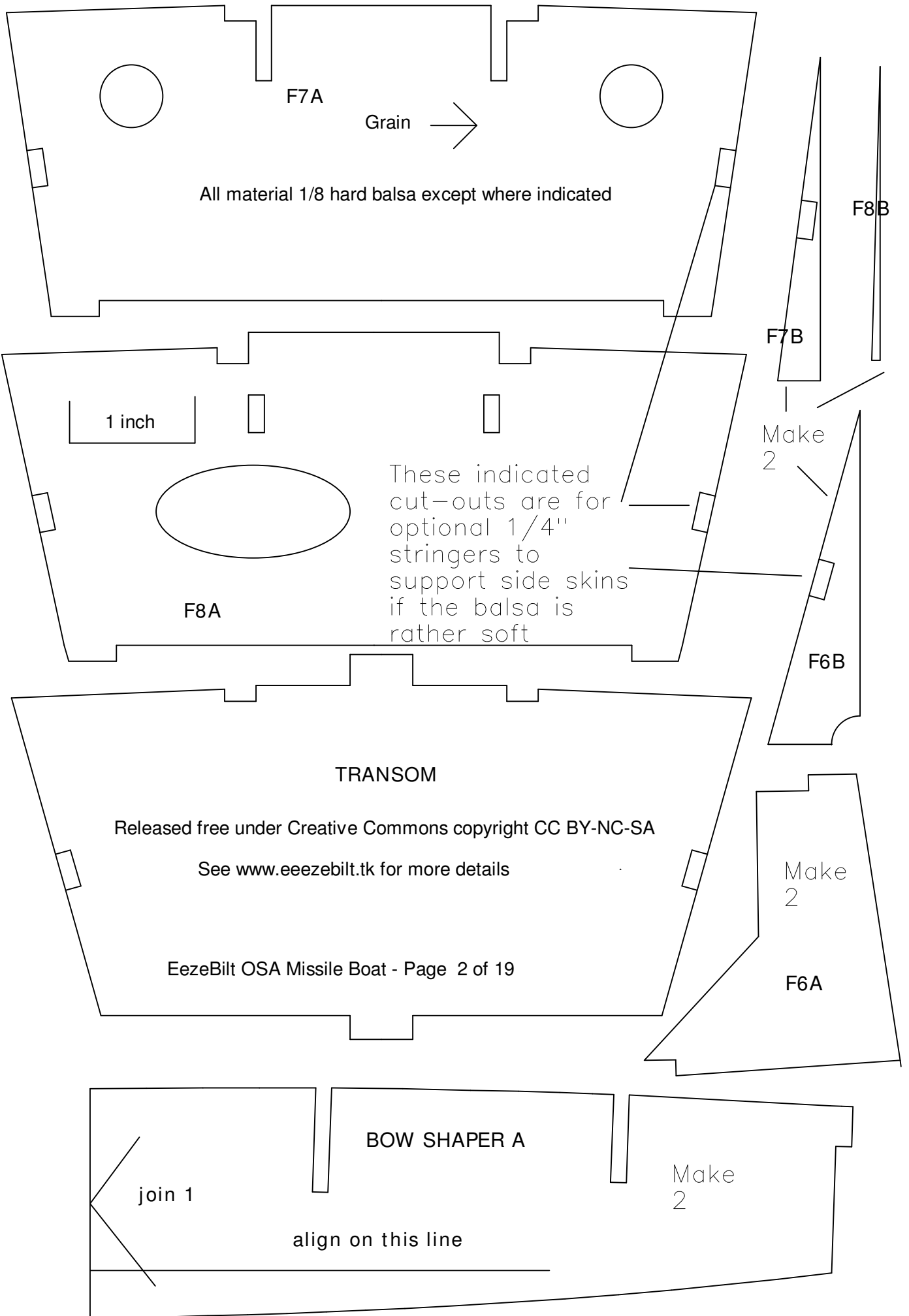

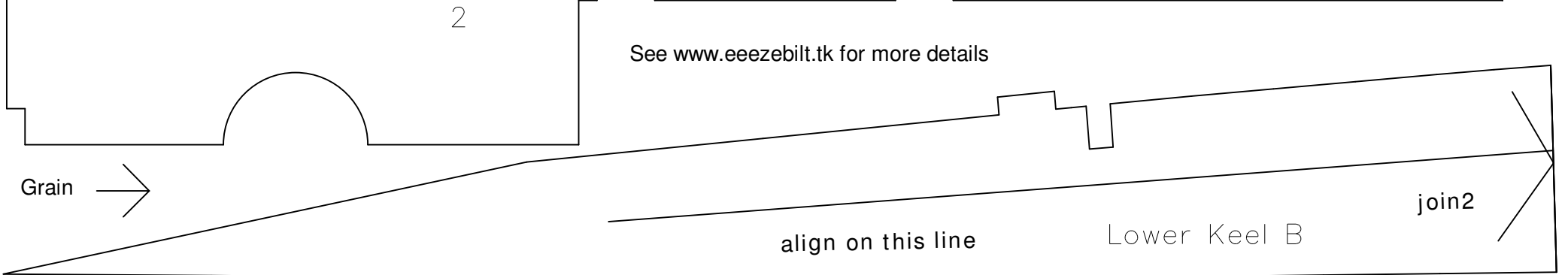
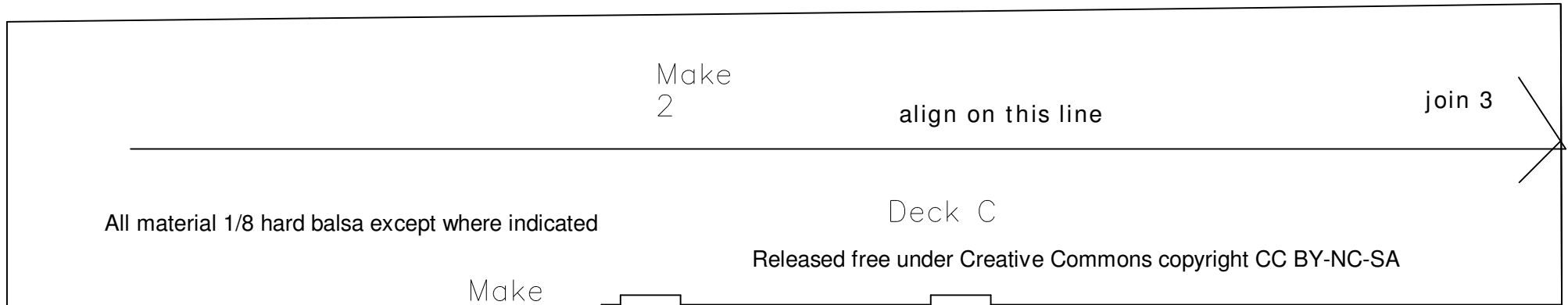
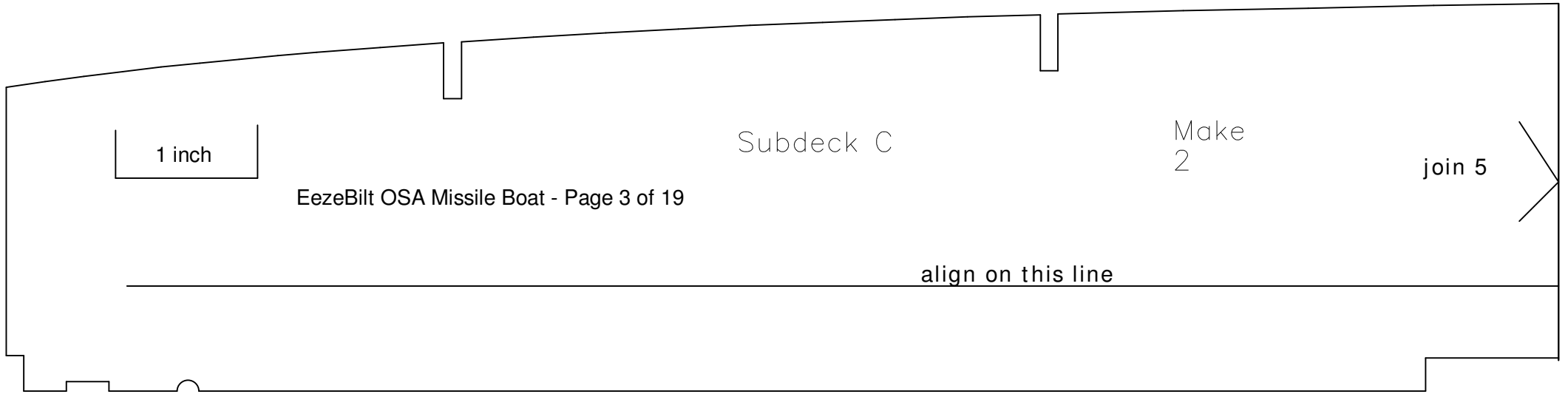

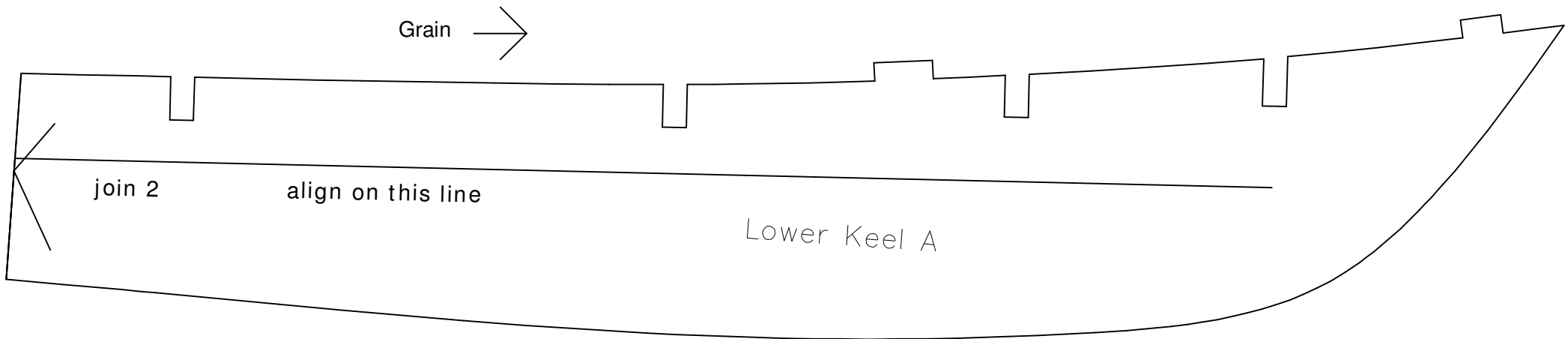
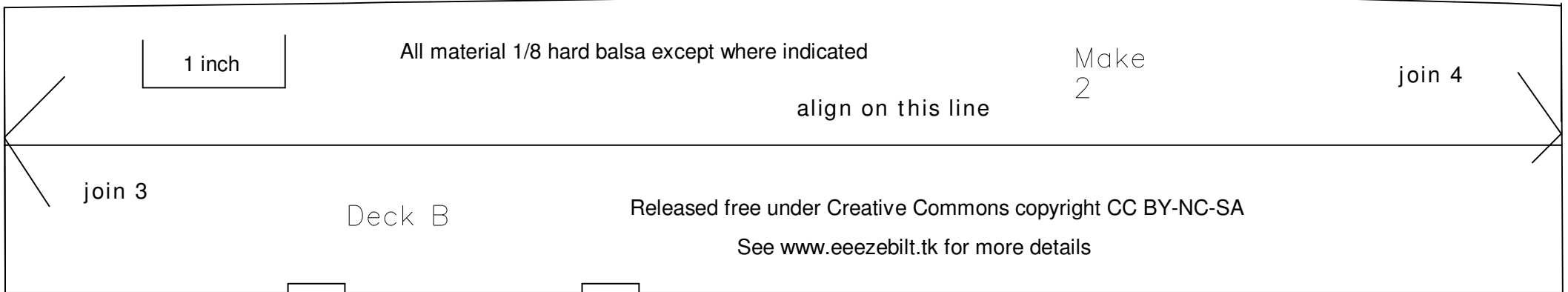
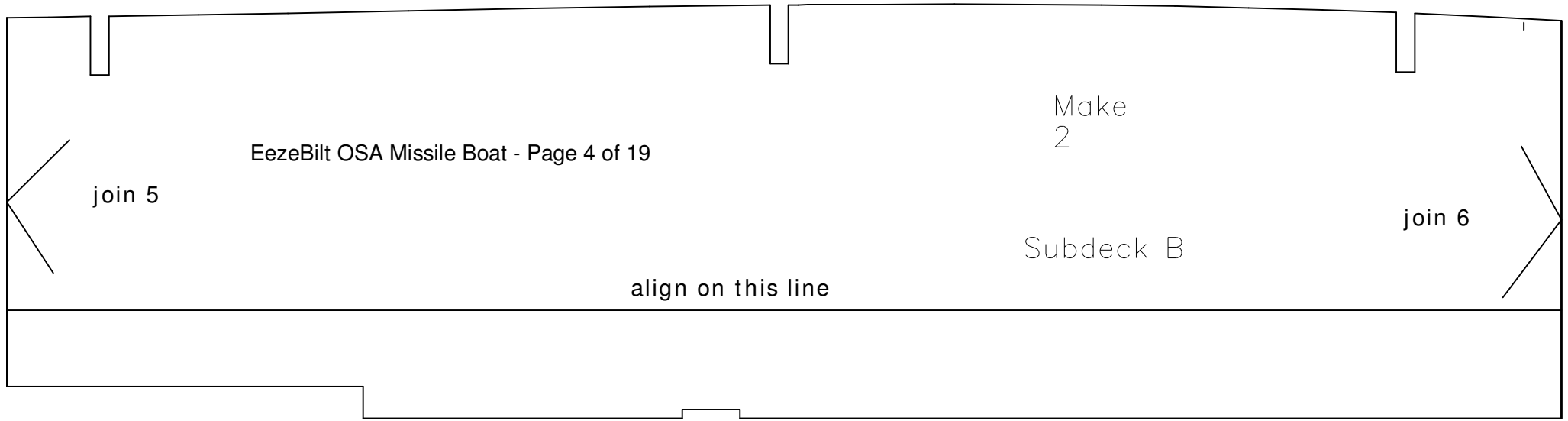

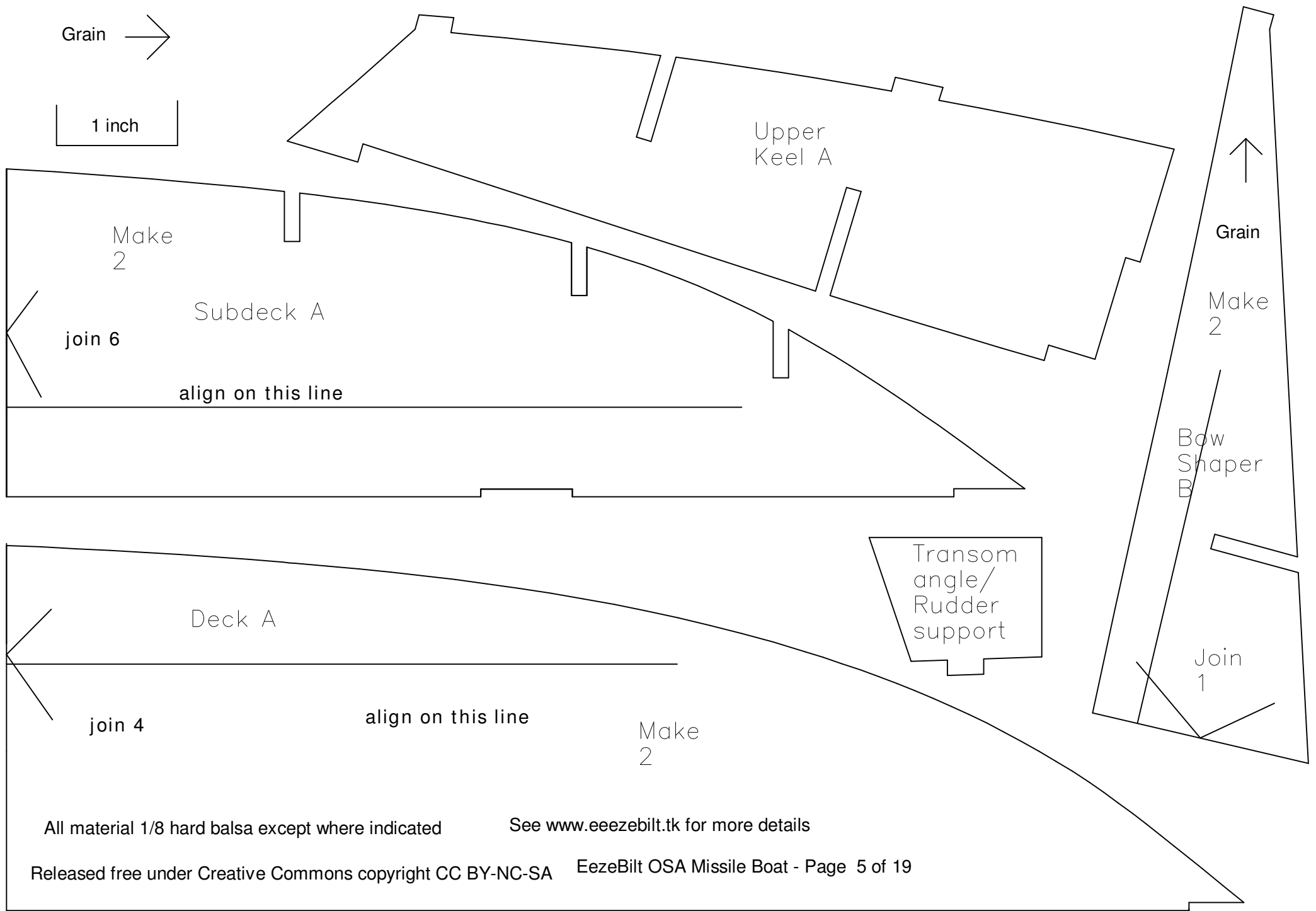

All material 1/8 hard balsa except where indicated

See www.eezebilt.tk for more details

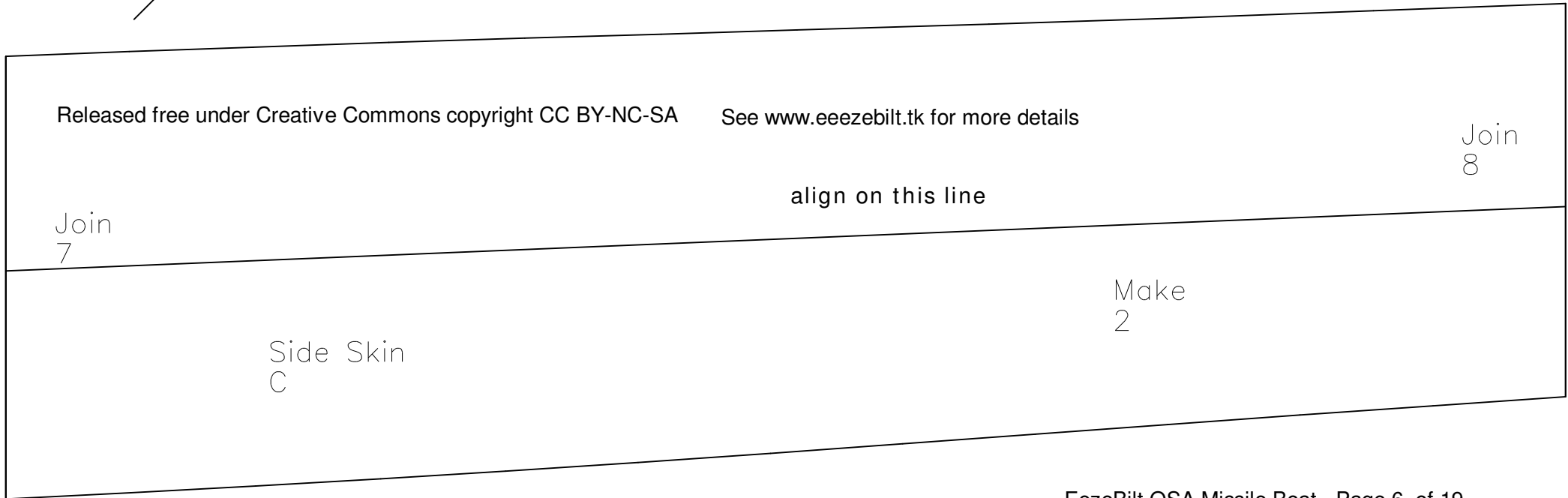
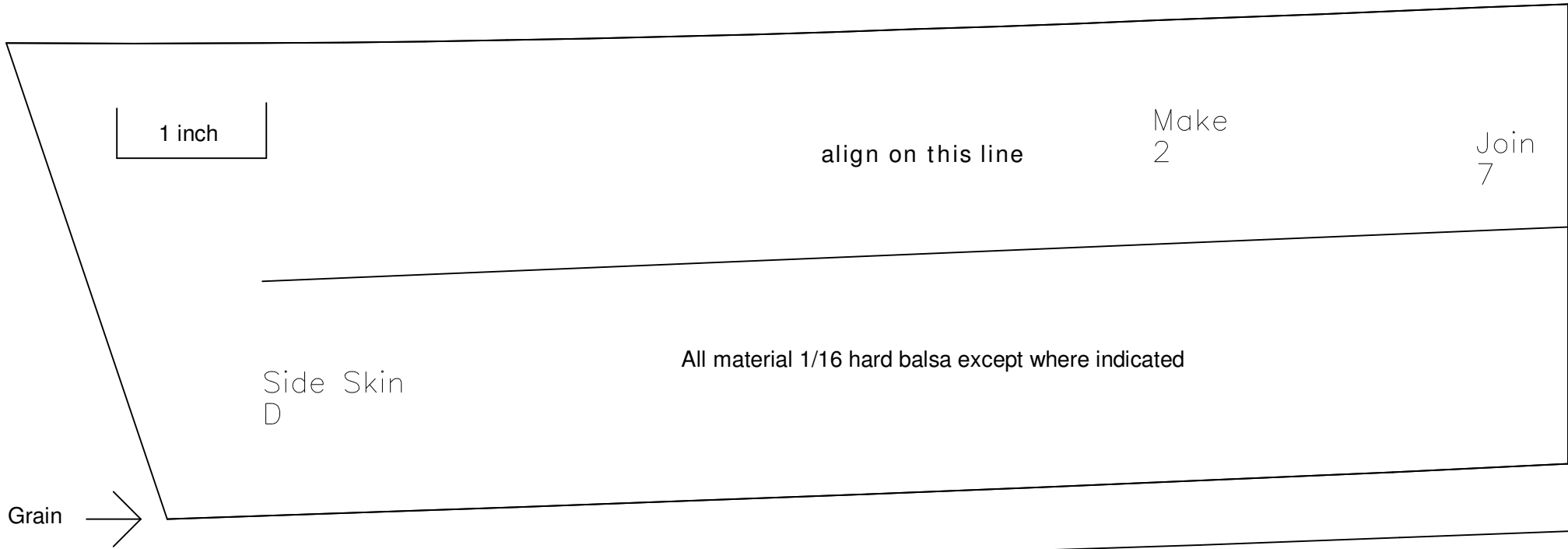

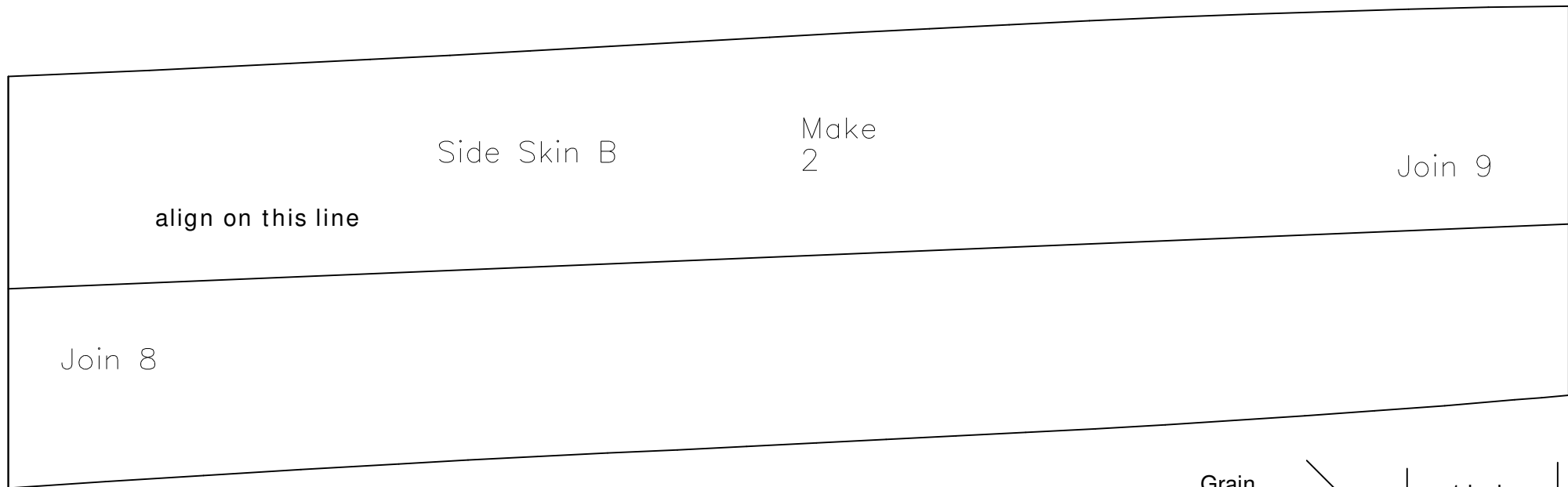

All material 1/16 hard balsa except where indicated

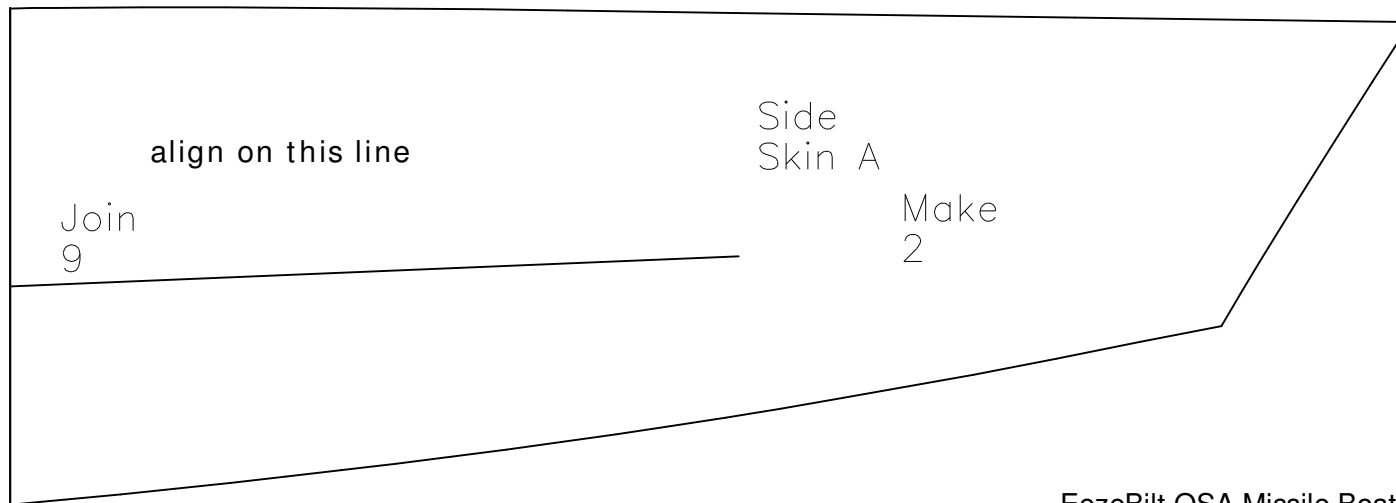

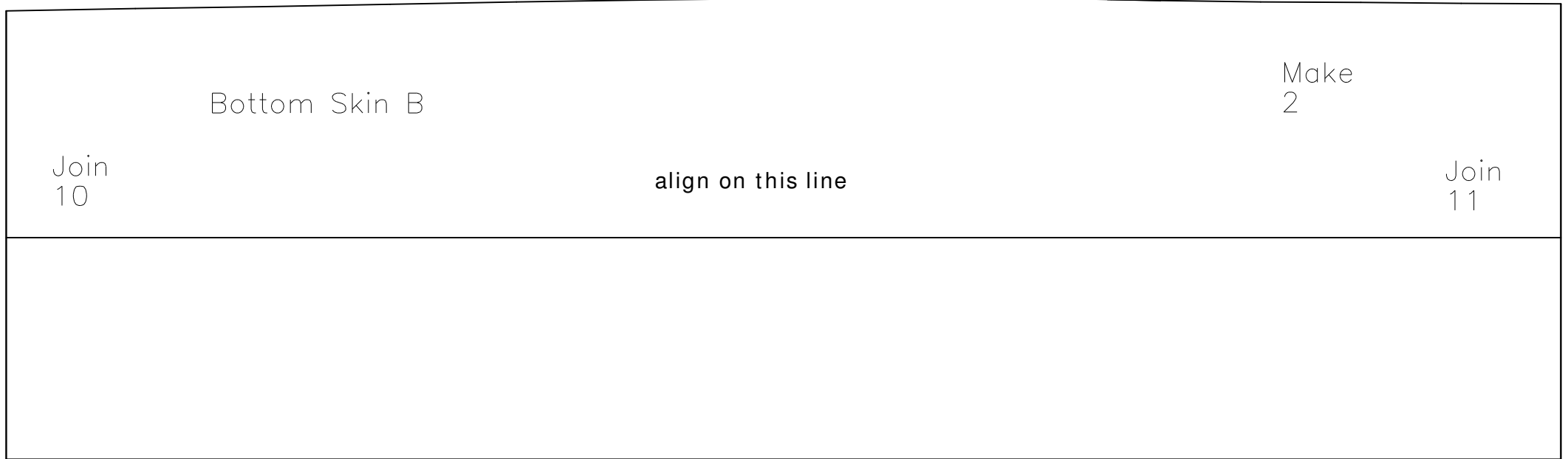
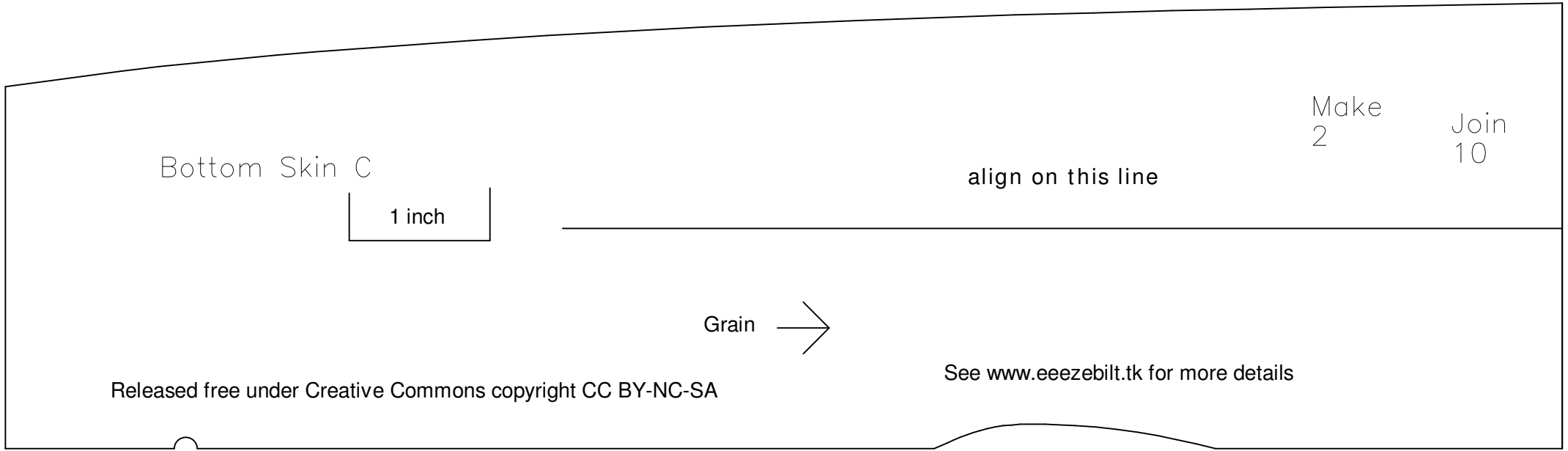

This hull requires 2 30" strips of 1/4" x 1/8" balsa for deck supports, and optionally 4 20" similar strips for side skin support if the material used seems weak. They are not illustrated. Cut these from sheet. The side skin support strips can be omitted if, for instance, bass wood is used for the skinning...

All skins shown here are drawn oversize, to allow for trimming. Once attached, they should be cut and sanded to match the hull framework.

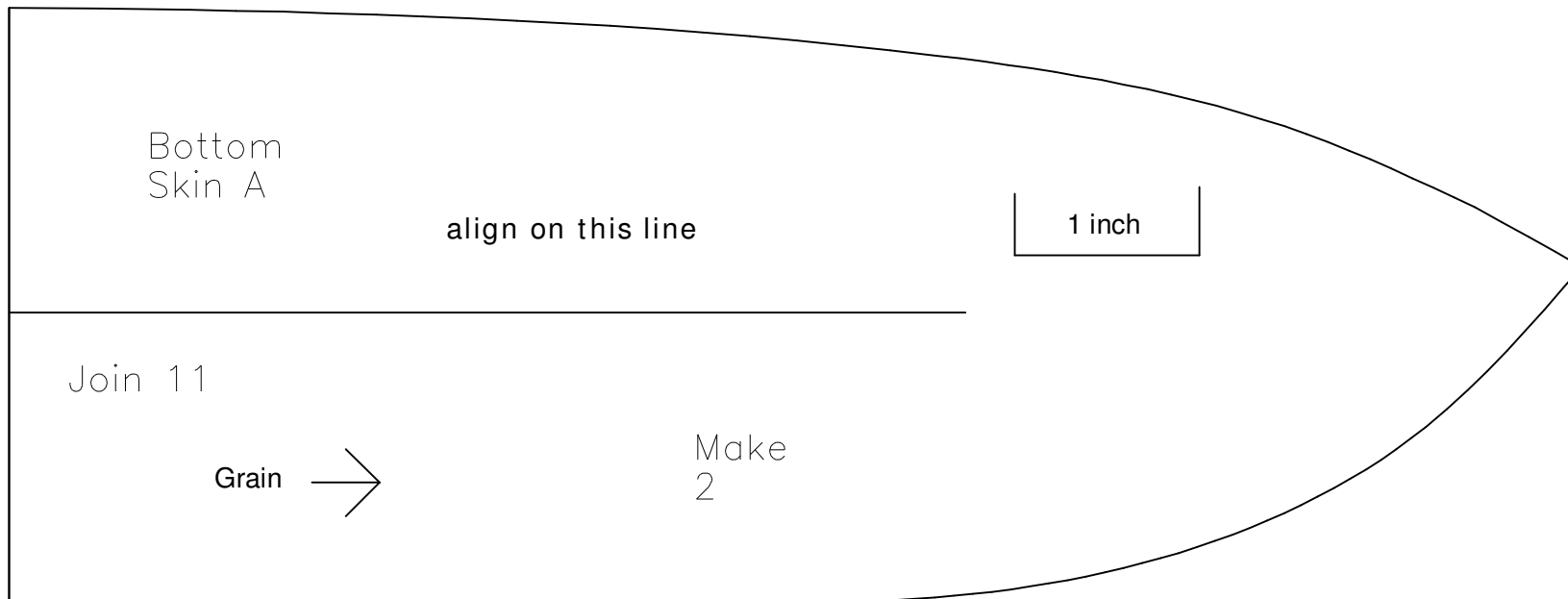

All material 1/16 hard balsa except where indicated

See www.eezebilt.tk for more details

Released free under Creative Commons copyright CC BY-NC-SA

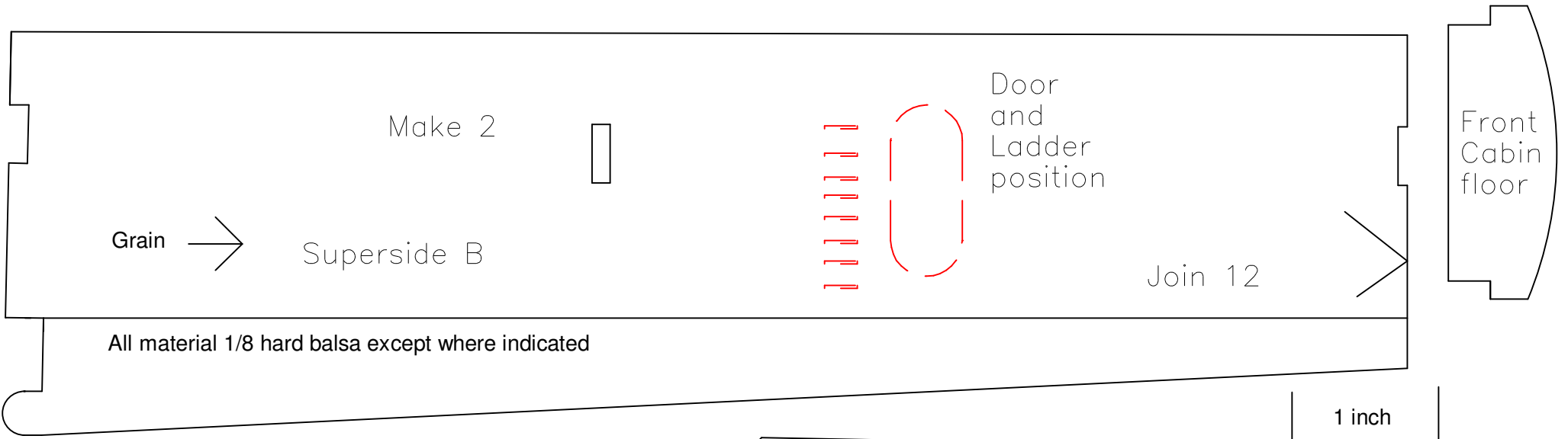

Released free under Creative Commons copyright CC BY-NC-SA
 See www.eezebilt.tk for more details

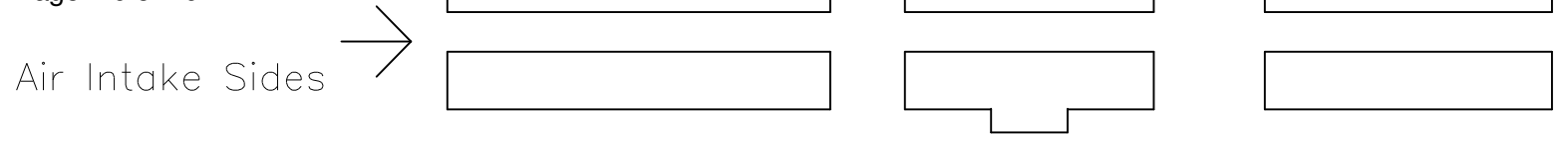
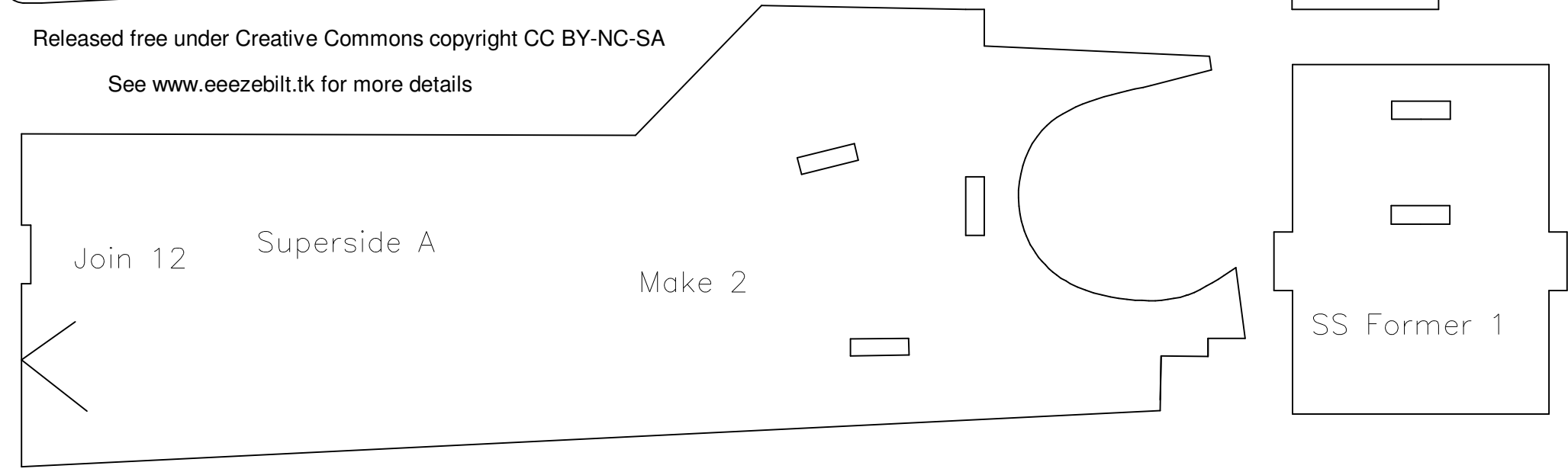

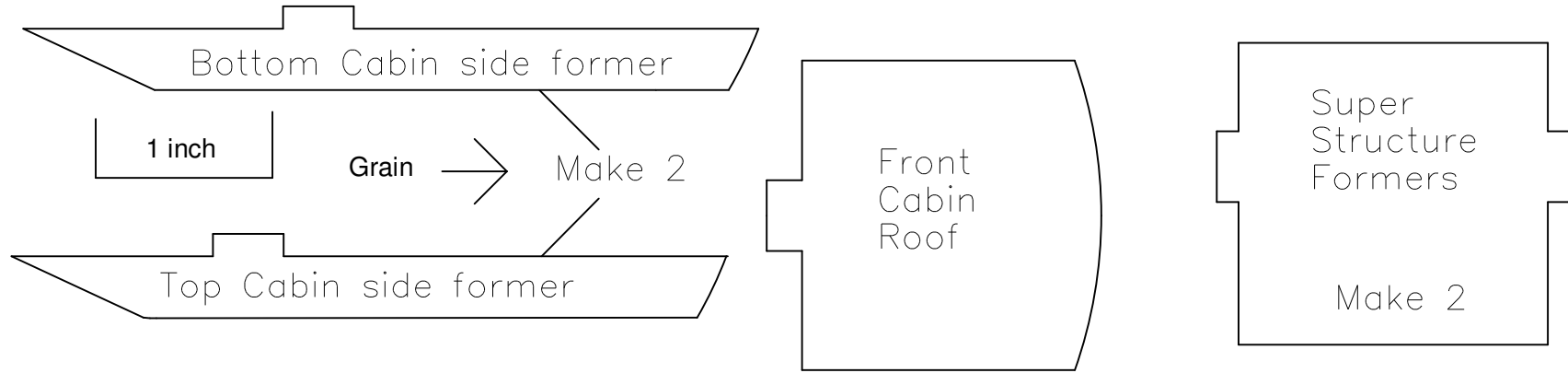

Released free under Creative Commons copyright CC BY-NC-SA

See www.eezebilt.tk for more details

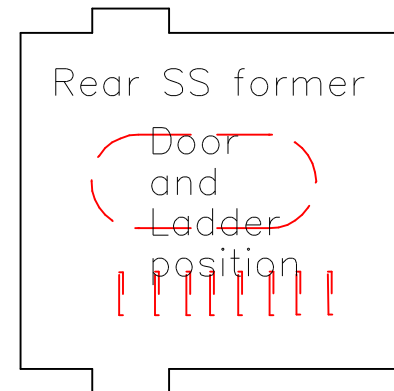
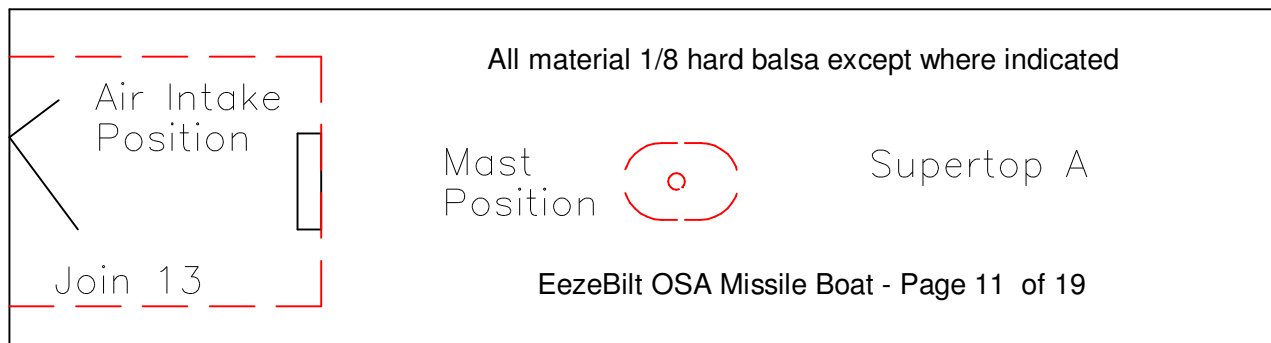

All material 1/16 hard balsa except where indicated

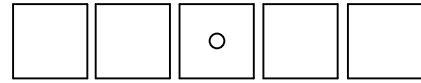
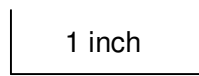
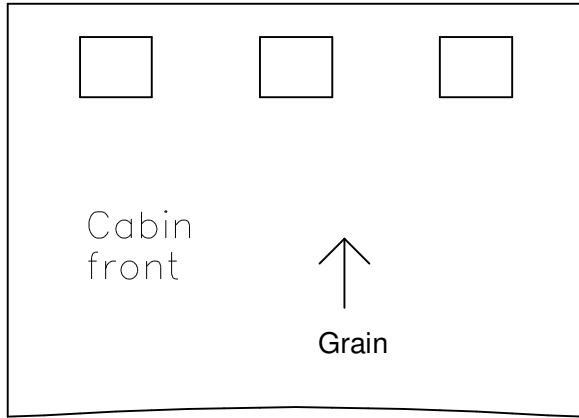

radar dome
mount – make a
cube from 5 balsa
sheets

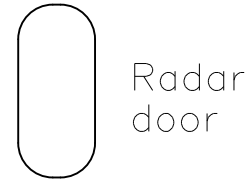
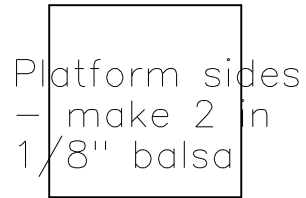
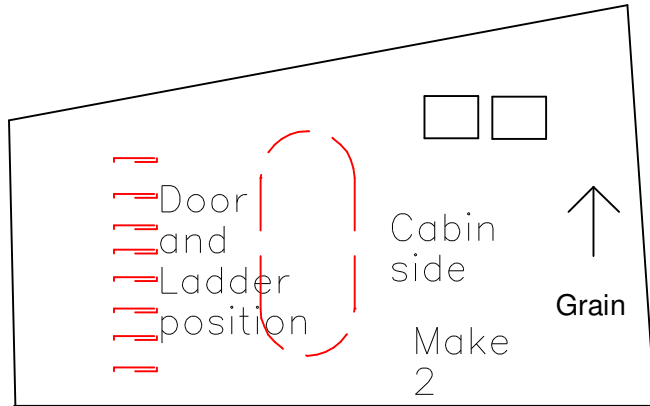
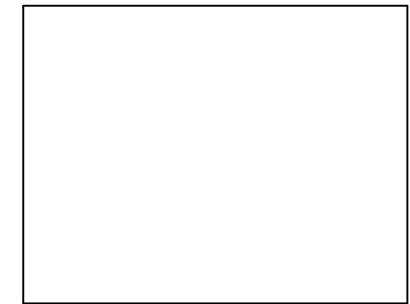
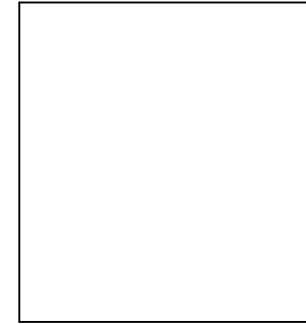
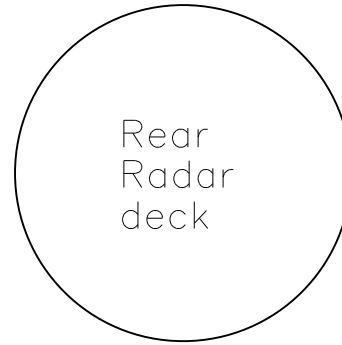

Air Intake
tops

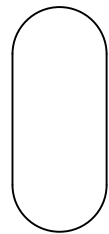

Door –
Make 5.

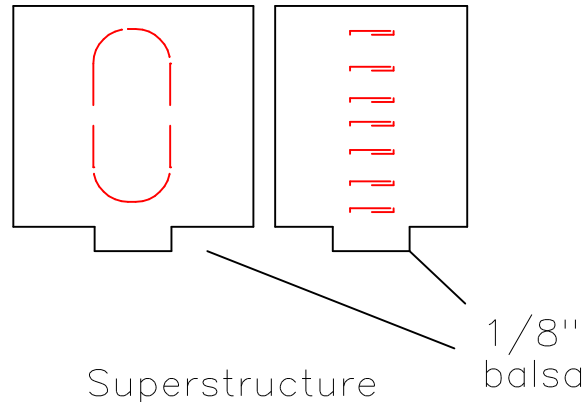

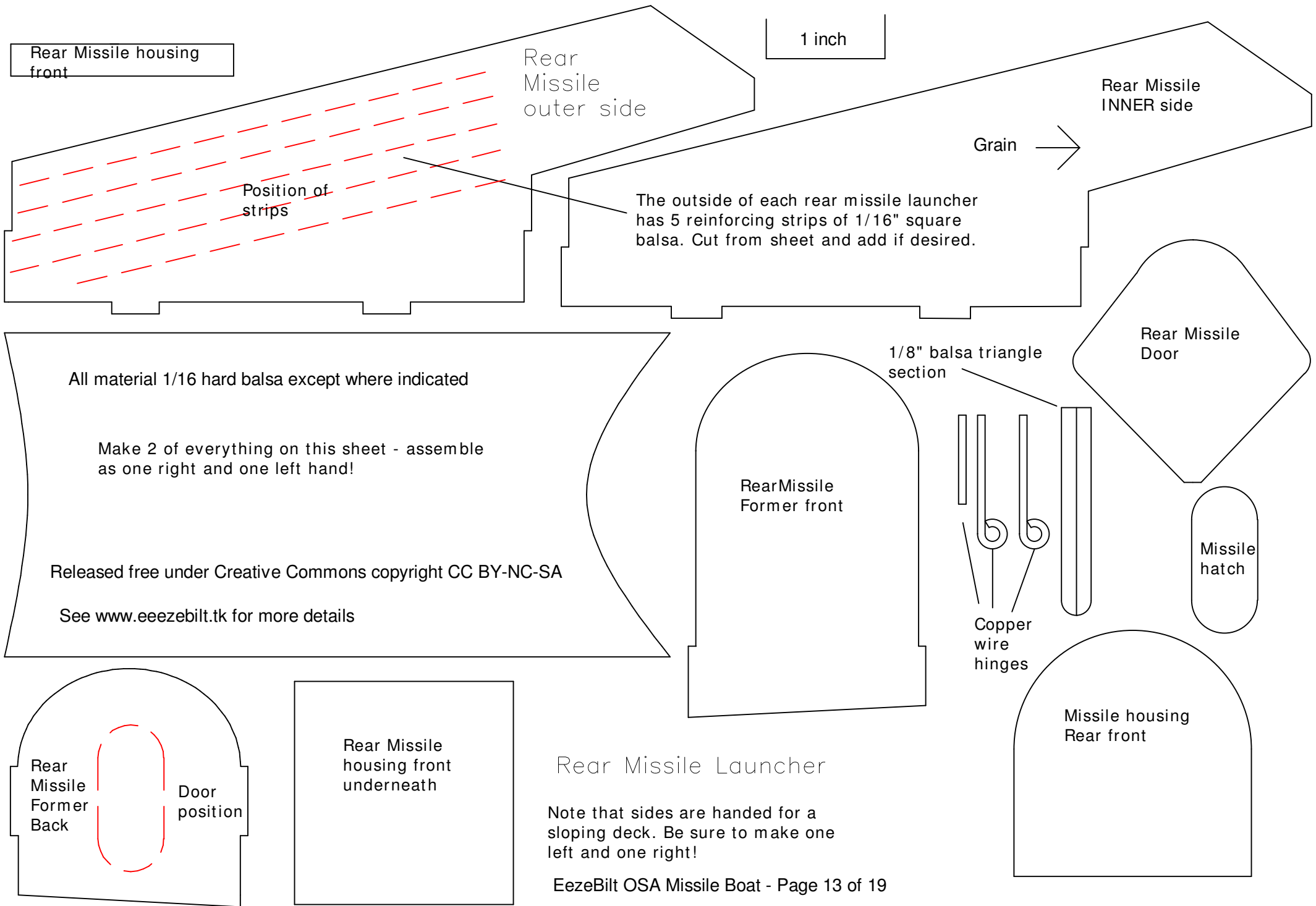

All material 1/16 hard balsa except where indicated

Make 2 of everything on this sheet - assemble as one right and one left hand!

Released free under Creative Commons copyright CC BY-NC-SA

See www.eezebilt.tk for more details

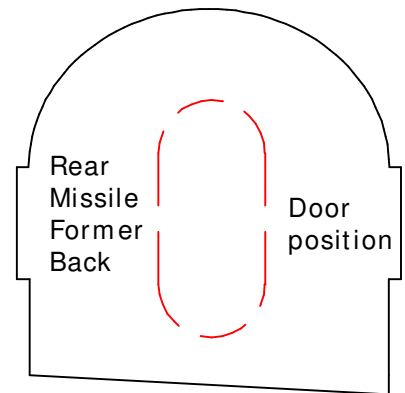

Rear Missile Launcher

Note that sides are handed for a sloping deck. Be sure to make one left and one right!

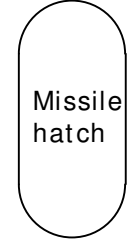
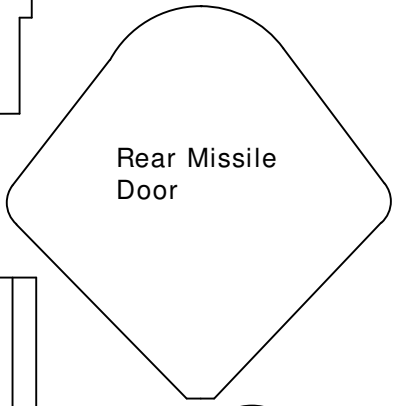
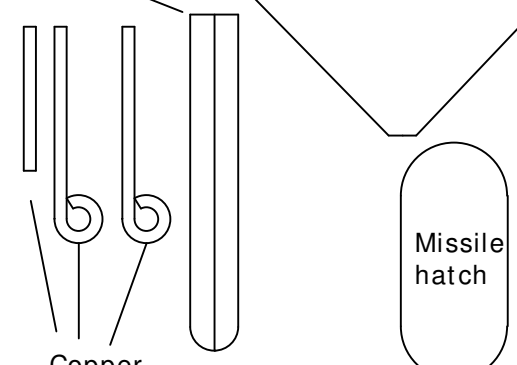
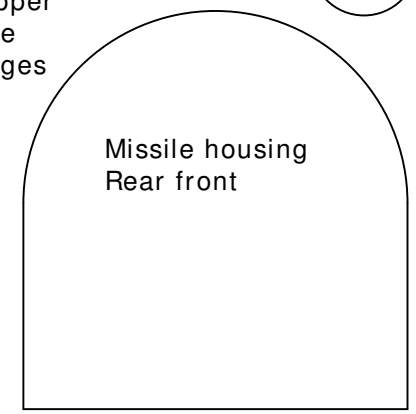

Front Missile Launcher

Note that sides are handed for a sloping deck. Be sure to make one left and one right!

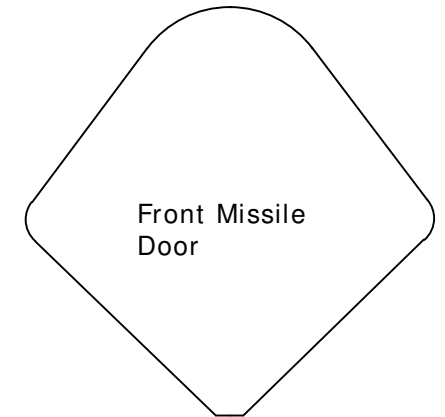
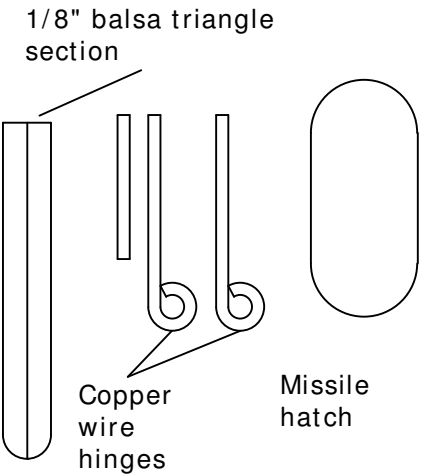
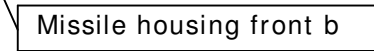
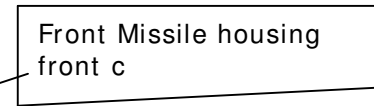
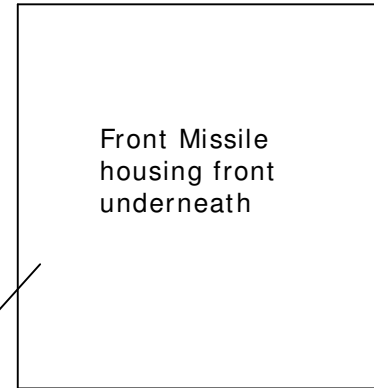
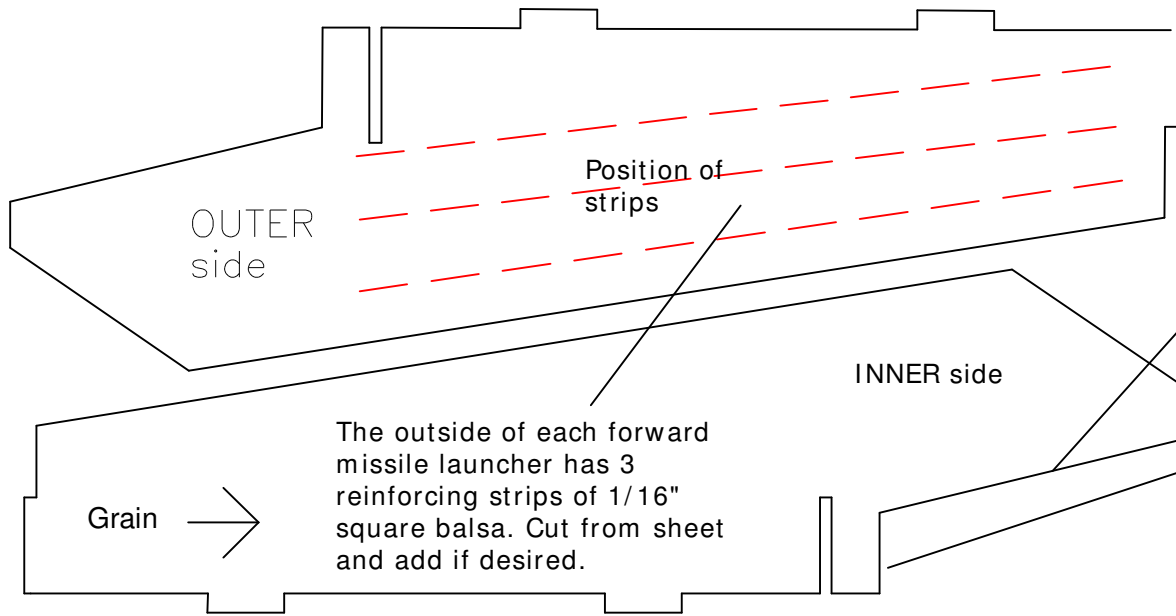
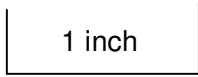

All material 1/16 hard balsa except where indicated

Make 2 of everything on this sheet - assemble as one right and one left hand!

See www.eezebilt.tk for more details

Released free under Creative Commons copyright CC BY-NC-SA

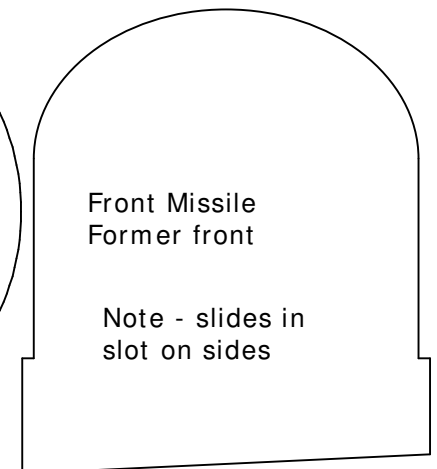
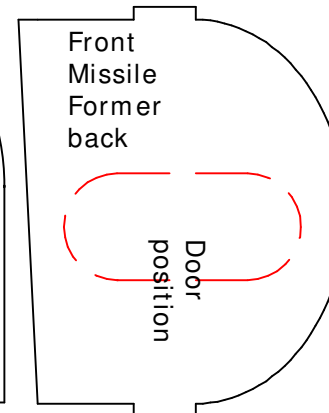
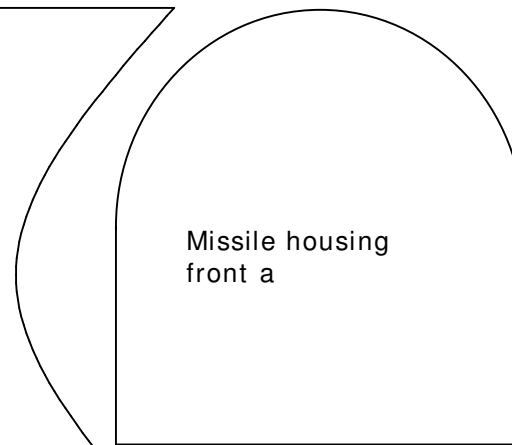

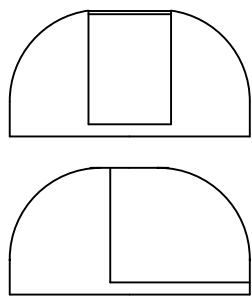

OSA Guns
twin AK-
230s

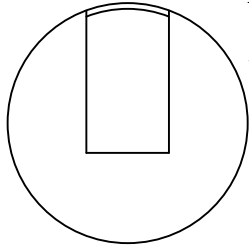

Make
2

You can make the guns in a number of ways. The drawings on the left show the overall shape, and this can be sanded to shape from the off-cuts of wood from circular hole-cutters (see the web site). But I made mine from household plastic items, as shown on the right.

The cylindrical base is best made from wood, but the conical shape is common on plastic bottles. Select one with a top diameter of around 3.5mm, and cut it to shape.

The dome housing is from a Kinder Egg container. Easy to buy on Ebay if there aren't any in your country!

The guns are simply brass tube, mounted in a segment of 1" diameter nylon or wood dowel, as shown on the right. To make the swivel mounting, I cut a thin piece of tinfoil to the disk shape shown, and then bent it in a 'U' shape. I wrapped a thick length of copper wire around the ridge left by the top of the bottle, then soldered the tinfoil to this ring. Glue a block of wood inside the plastic cone, then you can screw the gun mount to the top of the cone, and the bottom of the cone to the hull. Then just slide the dome housing onto the top.

tinfoil

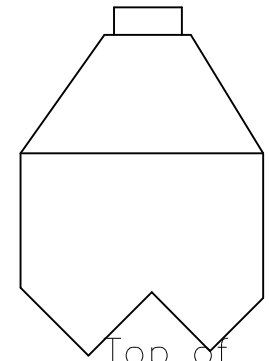
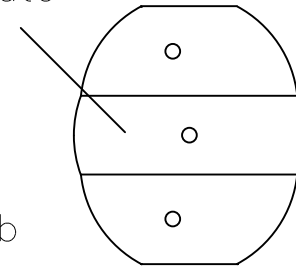

Top of
household
plastic bottle

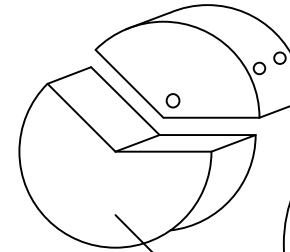

wood or
plastic disc

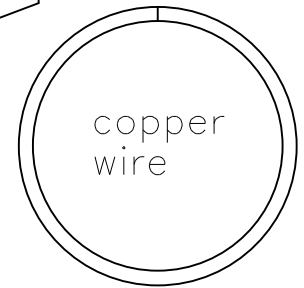

copper
wire

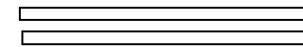

brass tubes

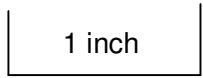
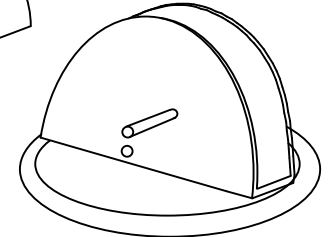
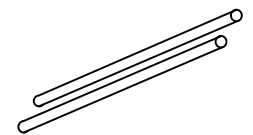
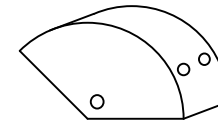

1 inch

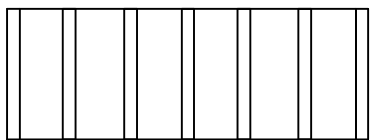
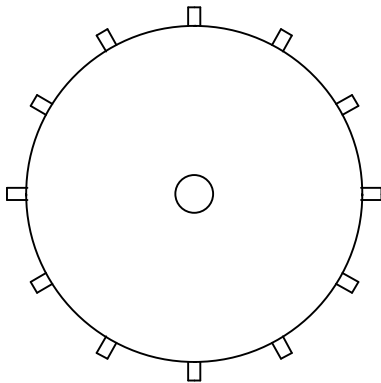
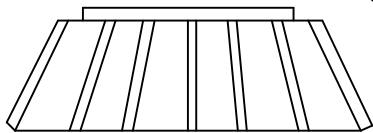
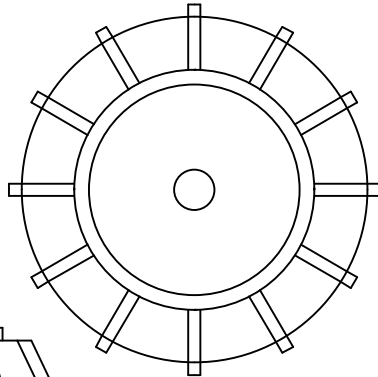

Add wooden bung to
match hole in rear deck

Radar Mast

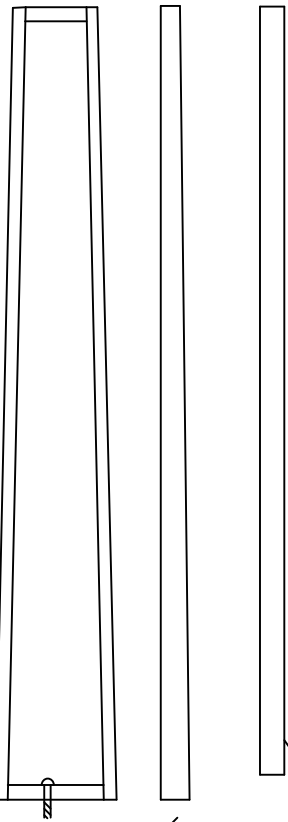
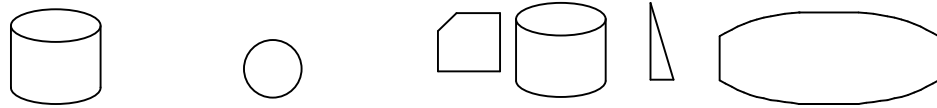

1/16" balsa
1/8" balsa

The mast is made using a top and bottom former, separated by a length of 1/8" balsa. Cut out about 8 tapered strips of 1/16" balsa, and glue around the edges. Fill in gaps with thin slivers of balsa, then sand smooth. Make a balsa cylinder 1/2" by 1/2" as the radar motor.

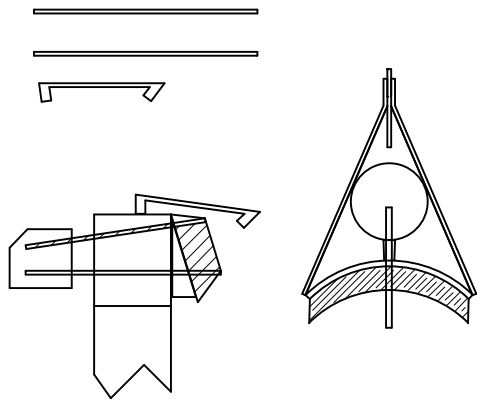

The radar dish is a curved bit of brass sheet. It is attached to the drum-shaped motor at an angle with the small balsa triangle. There is a weathercock vane behind it - make this out of brass sheet and solder it in position with 4 brass wires - 2 each side. Attach a curved brass rod on top for the transmitter horn.

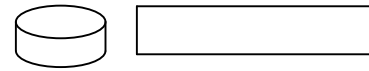

The lower radar is simply a 1/2" disk with a strip of 1/4" balsa glued above it.

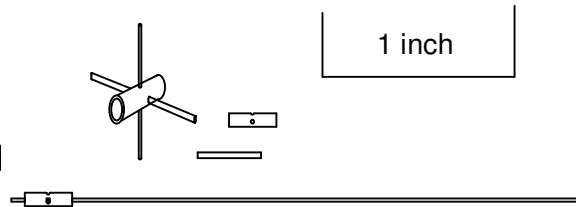

Make 2 D/F aerals - 2" and 3" long - for the side arms. Use a brass tube to mount a cross-piece at the top of each one.

See www.eezebilt.tk for more details

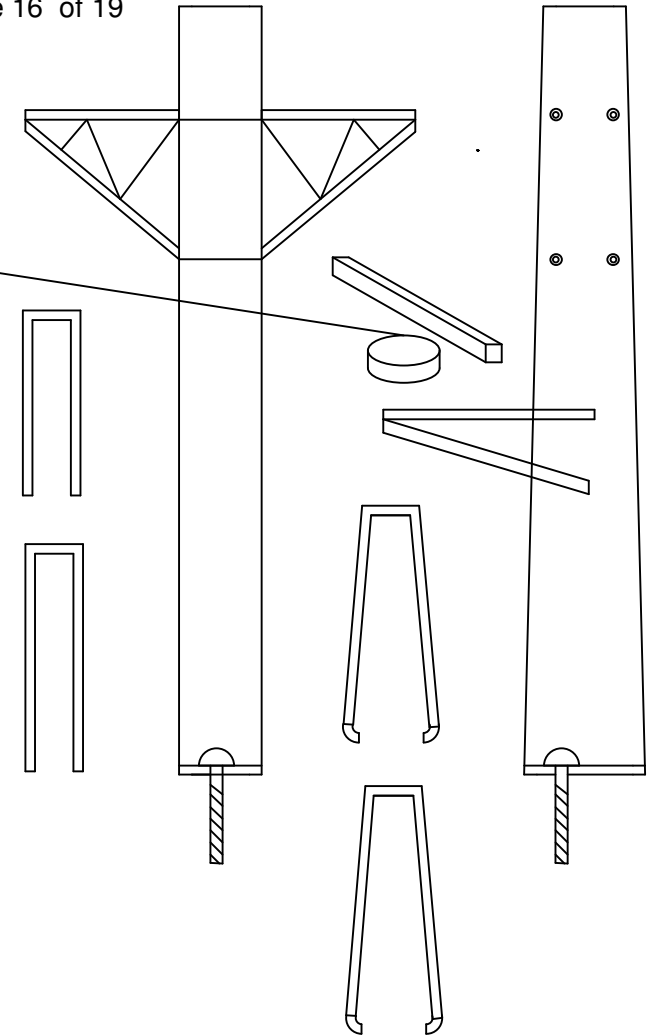

The mast arms are made from brass wire. Bend 'U' shapes as shown. glue into position and solder the tips together.

Add a small brass or balsa platform at each end to take a D/F aerial

Fittings

First, a word about scale. The OSA is modeled at the popular 1:48 scale(Railway 'O' gauge) so a lot of fittings and figures of this size can be bought commercially. Incidentally, the boat is quite close to scale - the major amendment is that the superstructure is somewhat bigger to enable easier access to the inside. A number of detail items are also lacking, such as life-rafts. There are many variants of these boats- the most common Warsaw Pact ones will have a more complex mast with extensive electronic countermeasures while the Chinese boats will have portholes at the bow and manual AA guns - therefore no rear AA radar. The model here is based on the INS NIPAT - an export version which had limited electronics, making the mast simpler!

If you want to make your own fittings, this section provides some examples of how things were done on the prototype. They are 1:1 scale so measurements can be taken from them.

Anchor - the model uses a Byers-type anchor about 1" long. I made one out of soldered tinsheet from the following shapes

1 inch

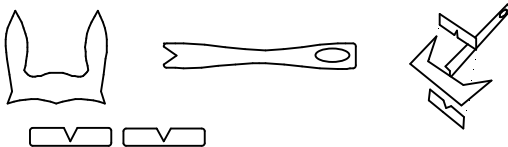

Winches - these are easily made from wood or metal rod, turned with a dip in the middle



Chain Guide - this was made from a bent edge of plastic sprue glued onto a base

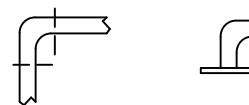

Aerials - make from telescopic brass to be removable. Solder washers on as shown

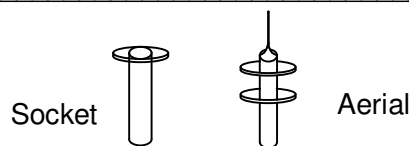

Windows are made from squares of acetate, with the edges painted, stuck on the outside of the frame

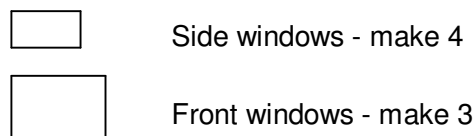

Make a winscreen out of thin acetate, and glue on top of the bridge parapet.

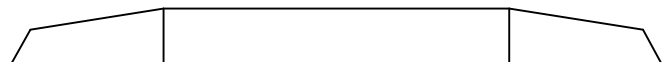

Fittings

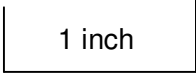

The prototype rudder was about 1.5" x 1", and shaped like the full-size version as illustrated. The actual full-size uses three props with three very small rudders of this odd shape - in practice any shape will be fine...



The model uses a long prop-shaft - 14". I used a 9.5" tube with a 14" shaft and supported the prop end with a skeg

Bollards should be about 1/2" long and 1/4" high. I make mine out of suitable-sized nails with a brass tube around them, soldered into a brass strip, as shown.

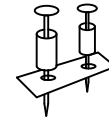

Make the rear radar dome from a cut-down Kinder Egg or turned from solid balsa to the size shown.

The Kinder Egg can be mounted with a bolt and two thick washers as indicated.

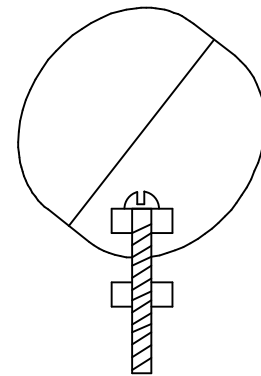
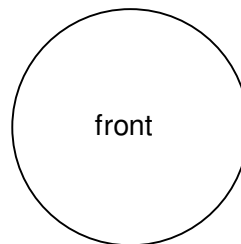
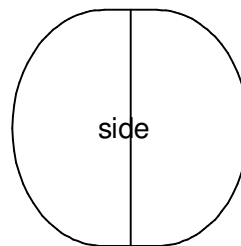

Mushroom vents are about 0.3" round, and 0.15" high. I made mine by cutting off the dimples from a sheet of pills, and gluing these domes onto a short length of dowel

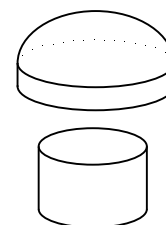

Hatches are simply 1/2" squares of balsa with a 0.7mm wire handle. Wire is also used for ladder rungs, and railings The full-size boat has 2-ball railings all around the deck edge - use 20mm height commercial ones for the model.

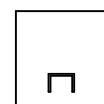

hatch



Ladder Rung

OSA Deck Layout

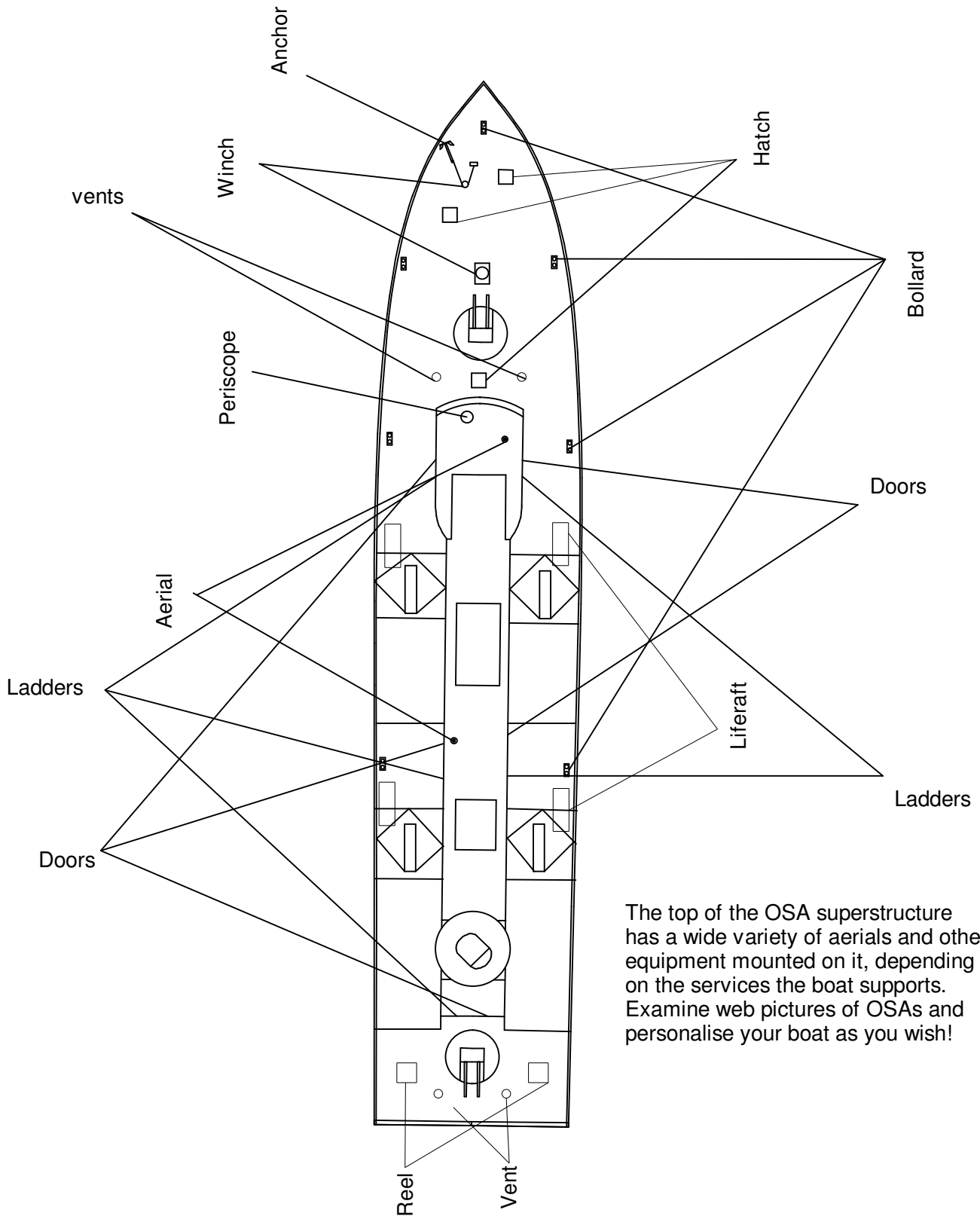

The top of the OSA superstructure has a wide variety of aerials and other equipment mounted on it, depending on the services the boat supports. Examine web pictures of OSAs and personalise your boat as you wish!



Yugoslav
Border
Guard



Somalia



Egypt

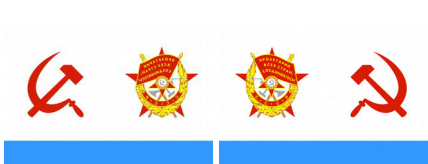

Soviet Naval Banner

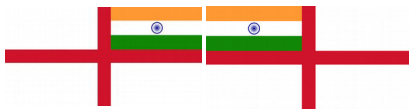

India Naval Ensign



Chinese Naval Ensign



North Korea Naval Ensign

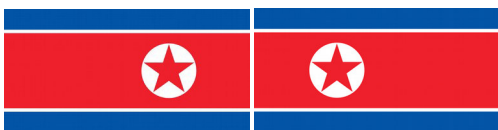

North Korea

A selection of flags of some operators of the OSA-1 Missile Boat. There were many others...