

Bevel edge

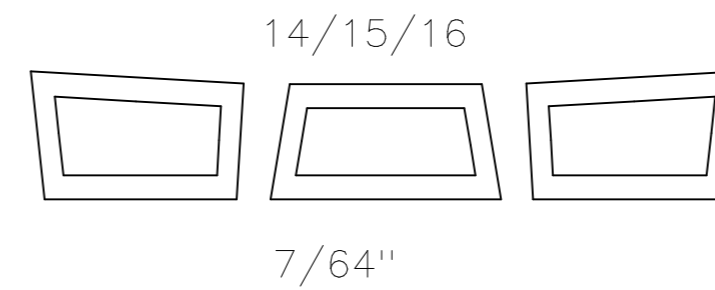

4/5/6

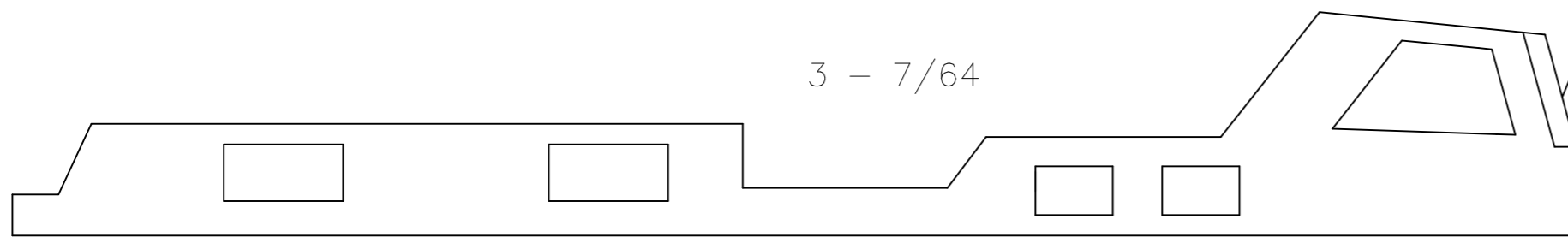
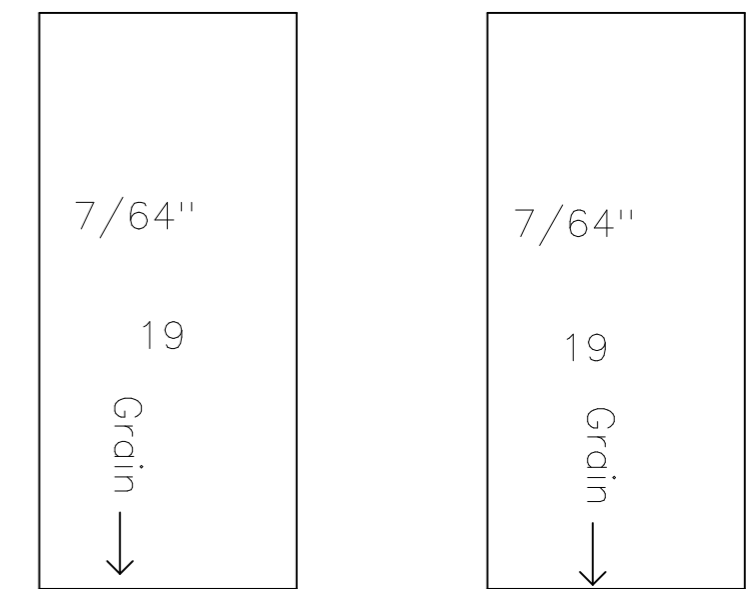
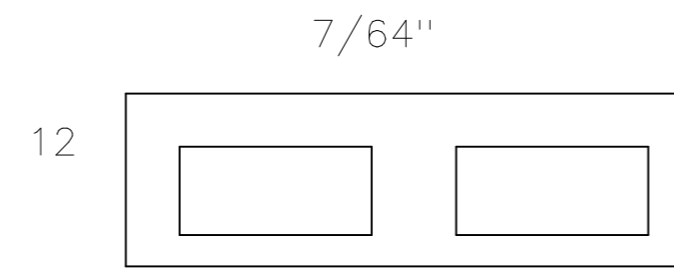
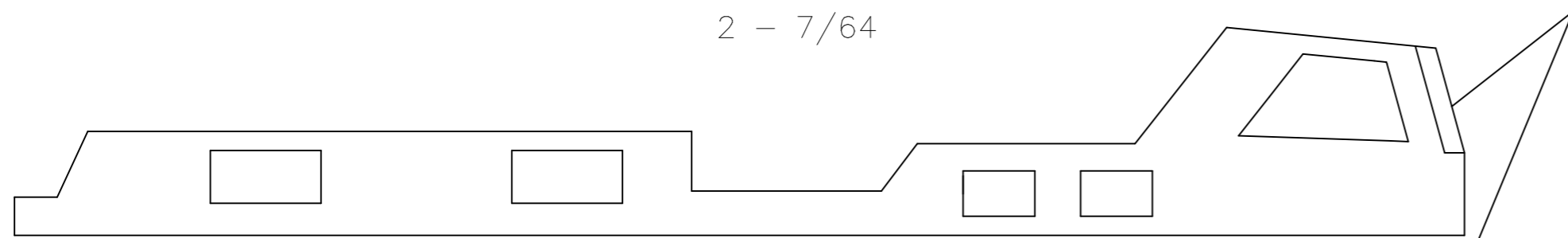
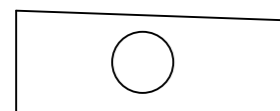
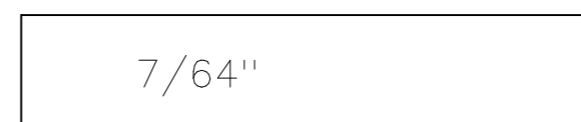
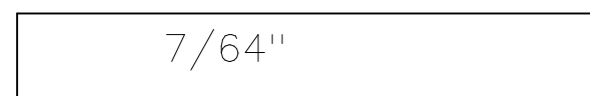

One Inch

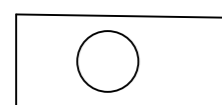
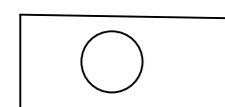

7/8/9

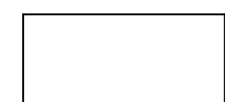

7/64"

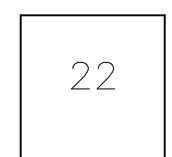
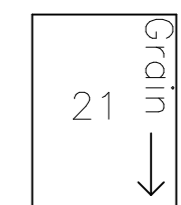
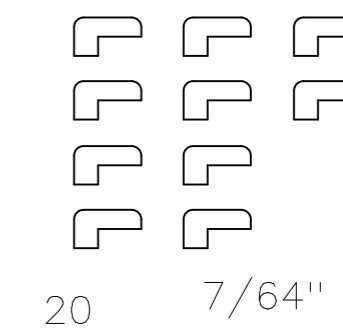
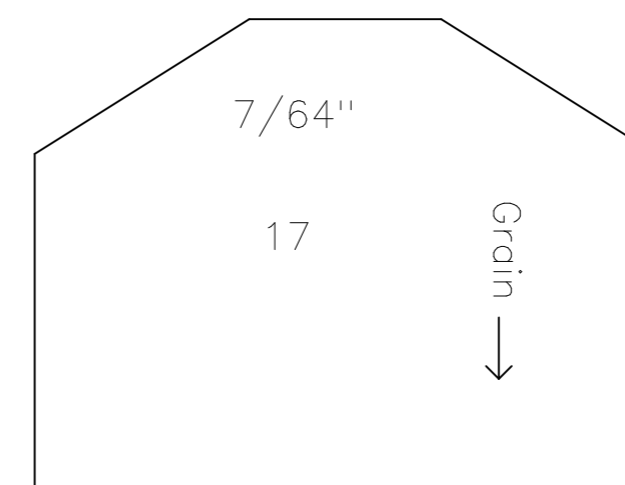

All wood is hard balsa. Grain is --> unless otherwise indicated

Released under Creative Commons license. For more details, see [Http://Marinecraft.tk](http://Marinecraft.tk)



Original wood was measured at 7/64" thickness. This may be original, or it may have shrunk! Balsa at 1/8" thickness is more readily available, and will be OK.